

Standard & Option

Details		25BE-X	30BE-X	35BE-X	Details		25BE-X	30BE-X	35BE-X		
OPERATION ROOM	OHG	Overheadguard (Height 2,175mm)	●	●	●	HYDRAULIC	2 Spool MCV	●	●	●	
	Cabin	Full Cabin	○	○	○		3 Spool MCV	○	○	○	
		Partial Cabin (Top, Front, Rear, Wiper)	○	○	○		4 Spool MCV	○	○	○	
	A/C	A/C, heater	○	○	○		Piping (V/VF/TF)	○	○	○	
		Seat	Grammer Seat + Belt + Arm rest + Belt switch	○	○	○	Hyd oil	VG 46 Oil	●	●	●
			Grammer Seat + Belt + Arm rest	○	○	○	VG 68 Oil for Tropical Area	○	○	○	
		Other Options	Non Suspension Seat + Belt + OPSS	●	●	●	VG 15 Oil for Cold Area	○	○	○	
	Others - Backrest		●	●	●	TIRE	Pneumatic Tire	○	○	N/A	
	Mast	Rear Horn	○	○	○		Tires	Solid Tire	●	●	●
		Extinguisher	○	○	○		Non-Marking Tire	○	○	○	
MAST	Fork	2 Stage V (3,000mm)	●	●	●	Lamp	Fron LED Lamp	○	○	○	
		2 Stage VF, 3 Stage TF	○	○	○		Fron & Rear LED Lamp	○	○	○	
	Carriage	Std. - 1,050mm	●	●	●	Rear Safety	LED Beacon Lamp	○	○	○	
		Opt. - 900mm/1,150mm ~ 2,400mm	○	○	○		Red Zone	○	○	○	
	Attachment	Hook	●	●	●		Blue Spot	○	○	○	
		Intergral Hook	○	○	○	Red Zone + Blue Spot	○	○	○		
BATTERY	Battery	Special Site	○	○	○	Mirror	Panorama Mirror	●	●	●	
		Side Shift	○	○	○		Side LH/RH & Panorama Mirror	○	○	○	
		Charger	Lead acid - 25BE-X 48V/600Ah, 30/35BE-X 80V/500Ah	○	○	○	Camera	Rear camera	○	○	○
	Lead acid - 25BE-X 48V/660Ah, 30/35BE-X 80V/550Ah		○	○	○	Front & rear camera		○	○	○	
	Trolley	Li-ion - 25BE-X 51.2V/450Ah, 30/35BE-X 83.2V/450Ah	○	○	○	SAFETY / CONVENIENCE	Load Sensor	○	○	○	
		Lead acid - 3P 220/380/440V, 50/60Hz	○	○	○		OPSS - Travel & Mast	○	○	○	
		Li-Ion - 3P 380/440V, 50/60Hz	○	○	○		Travel Alarm	○	○	○	
	Battery Trolley (Narrow/Wide)	○	○	○	Seatbelt Interlock		○	○	○		

● STD / ○ OPT



25/30 35BE-X

BE-X Series Battery Forklift Truck



HYUNDAI BE-X Series, a game changer that perfectly satisfied on-site needs in the electric vehicle market

Real customer satisfaction is sustained by Hyundai forklift by launching the BE-X Series boasting of enhanced cost-effectiveness and improved outdoor operation properties compared with the B-X Series that had been launched with the VOC of service sites and market trends reflected.

PRODUCT FEATURES OVERVIEW

ALL YOU NEED IS, BE-X

Release of the BE-X series,
an icon of innovation

- Application of drive axle with optimum performances for service conditions and less driving power loss

8.2%

Enhancement of energy efficiency
by 8.2% compared with B-9F

- Application of single-drive system and low-noise drive axle

6.5dB

Reduced noise to operators by
6.5dB compared with B-9F

EXCELLENT
PRODUCTIVITY



Outstanding Productivity

- Deep drop type vehicle structure-improved driving and work safety
- Achieves the best energy efficiency level in its vehicle class
- LiFePo4 lithium-ion battery with excellent price-to-performance characteristics **Option**
- IP Class 54 driving and pump motors – Expanded service area
- Application of Dual Micom ZAPI Controller
- Enhanced energy efficiency by 8.2%
- Application of power selection button for drive and pump motors

Improved Convenience

- Ergonomically redesigned operator room
- A new cluster with superior visibility that can be manipulated easily.
- Hood fixation-type hydraulic control lever
- Optimum step height and width for convenient getting on/off
- A/C & heater with improved cooling and heating performance **Option**
- Noise in the driver's seat is reduced by 6.5 dB
- Two-channel wireless front/rear cameras **Option**

Maximized Safety

- Speed limit
- Seat belt interlock **Option**
- Speed limiting function when traveling with elevated load **Option**
- Operator Presence Sensing System(OPSS) **Option**
- Antiroll back system prevents the machine from rolling back after coming to a stop on an incline
- Safety warning lamp - Blue spots and red zones **Option**

Economical follow-up management

- A battery replacement system that doesn't require a crane structure
- Battery connector specialized for charging
- Controller with high reliability and self-diagnosis capability
- Sealed micro switches - MCV
- Hydraulic motor room cooling system without air vortex
- Long-lifetime LED lamps - Front/Rear work lamps

ENVIRONMENT FRIENDLY
GREAT PRODUCTIVITY, DURABILITY

Outstanding Productivity

Productivity is increased with optimized vehicle performance

25BE-X is designed focused on TCO with the application of iron phosphate lithium ion batteries and IP54 drive & pump motors for boasting of optimized performances, long lifetime, and excellent cost-effectiveness.



25/30
35BE-X

Energy consumption levels that are quite revolutionary

Energy efficiency is improved by 8.2% compared with the 9F Series thanks to the application of drive & axle assemblies with less power loss whose drive and hydraulic performances are optimized for service conditions.

* Energy consumption is based on the test standards of the Company.

Energy efficiency

8.2%

Single-drive axle & IP54 motor - Wider service areas

As single-drive system without exposure of the traction motor, IP 54 motors, and 80V batteries are applied, the service areas of forklifts are expanded to the outdoor environment. Moreover, driving noise is reduced by 6.5dB thanks to the application of low-noise axle.

* 80V system: 30/35BE-X only.



A deep drop type frame that has a low center of gravity

The deep-drop type wherein batteries are arranged between the front wheels and rear wheels lowered the center of gravity of the body, providing relatively high driving and lifting work stability.



Optimization of the work environment and performance

The equipment may be efficiently operated with the easy selection of driving and mast work speeds to meet work conditions with the use of up/down buttons in the cluster.

- ① Up button: Drive and work control (H-N-E)
- ② Down button: Turtle



Lithium-ion battery with excellent price-to-performance characteristics Option

LiFePo4 lithium ion batteries have excellent 2hour quick charge and frequent charge properties, and 2-shift operation/day is possible without the replacement of batteries. In addition, as energy conversion efficiency is high and long-term follow-up management is not required, it is highly economical compared with traditional lead batteries.



ZAPI Controller

Dual micom are installed to improve controller system reliability that satisfy the EU functional safety regulations, and water-proof & dust-proof level IP65 large-capacity ZAPI Controller is installed.



OUTSTANDING OPERABILITY
ERGONOMICS

Improved Convenience

A working environment that meets the comfort needs of the operator

A satisfied vehicle operator translates to higher productivity. The upgraded operator room and the numerous functions developed with the operator's comforts in mind allow the operator to work more efficiently and comfortably.



25/30
35BE-X

An redesigned ergonomic operator room

The operation space of B-X, a sister model having optimized design with various upgraded ergonomic devices and optimum height of monitors and seat, is applied for convenient and efficient operation.

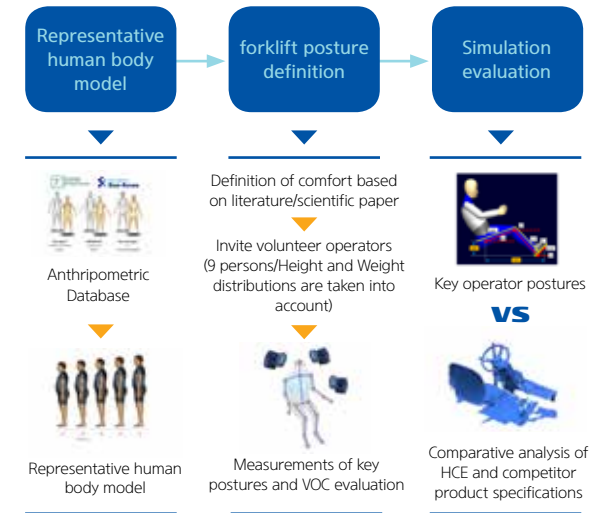

Multifunction digital cluster

The driver is able to check the operation conditions in real time on the multifunction digital cluster designed to ensure the visibility of major information during operation. In addition, various additional functions are embedded in the cluster for safe and convenient equipment management.



Hood fixation-type hydraulic control lever

The MCV lever, which is frequently used, is arranged on the right hood of the operator. This type reduces physical motion and fatigue compared with the dashboard-fixation type.



Full-suspension seat – Grammer Option

The full suspension seat of Grammer of Germany has an adjustable cushion depending on the weight of the driver, and convenience specifications such as seat belt switch, arm rests, and heater are optional.

* STD seat : Semi suspension



Steps for convenient getting on/off

The deep-drop frame lowered the seat height and the first and second steps are also lowered by about 100mm compared with the conventional types. The width is also increased for convenient getting on/off. In addition, the distance between the seat and head guard is increased by about 40mm for enhanced comfort.

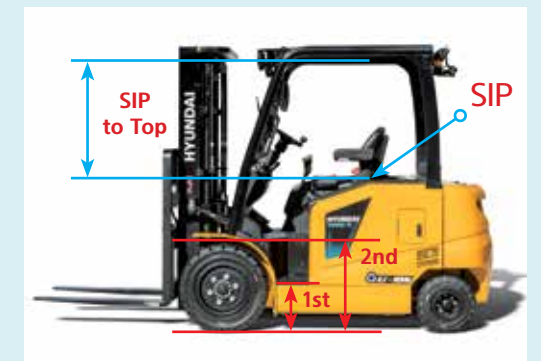

Hydraulic boosted-type steering wheel

The external diameter of light and sensible HPS-type steering handle is reduced by 20mm for operation convenience, and the wheel column may be tilted 12.5 degrees forward/backward to suit the body of the operator.

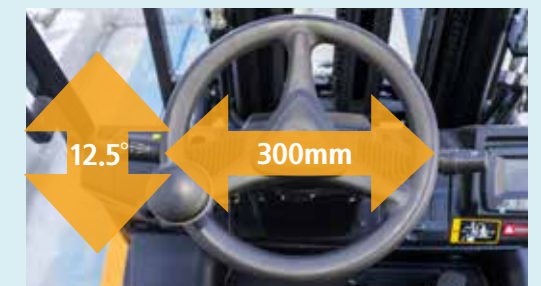

Maximized Safety

Minimized risks of accidents

Above all else, the likelihood of accidents on the field is fundamentally eliminated through scientific vehicle body design that thinks of safety first and diverse and active safety specifications.



A safety system that eliminates the risks of accidents in advance

Function and system for preventing safety accidents in the event of an operator mistake or unforeseen situation block the event from developing into an accident. The burden of maintaining safety while performing difficult and complex jobs is removed from the shoulders of the operator.

Anti-Roll back system

This system prevents the forklift from rolling rapidly down a slope when the accel pedal & brake pedal are not applied while also offering improved ramp start-up abilities.



Operator presence sensing system(OPSS) Option

The OPSS restricts driving, lifting, and tilting in when the operator leaves the driver's seat in order to prevent safety accidents.

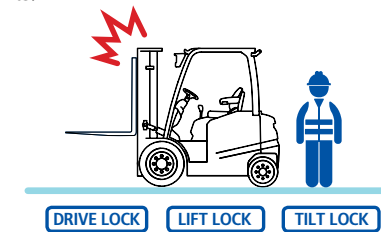

Limited travel speed when driving with elevated load Option

The travel speed is limited to 3km/h when the fork is lifted to a height of 500mm or it is above the free mast elevation height, in order to ensure the cargo doesn't fall off and the forklift doesn't get overturned.

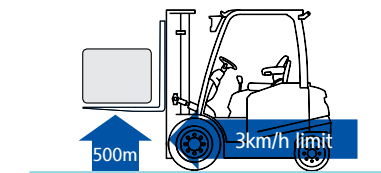

Speed limit

Maximum travel speed of the equipment may be set to meet the safety speed of the site through a multifunctional monitor, and safety accidents caused by overspeed may be prevented. Even when maximum speed is limited, gradeability and lifting performance are maintained at top levels.



Front/Rear cameras Option

The wireless front/rear camera system supplies the two-channel monitor with information on the front/rear. A front camera is installed on the lateral side of the fork, helping in the safe identification of the position of pallets during high-rack operation.



Rear Grip Bar & Horn Option

The rear steering wheel with horn embedded allows the driver to keep a stable, convenient posture during rear driving and operate the horn rapidly without changing the driving posture in case of an emergency situation.



LED work lamps and safety warning lamp

Bright and long-life LED lamps are applied to the front/rear work lamps and direction indicators. Moreover, beacon lamp, blue spots, and red zone lamps are optional for the notification of motion of the forklift to the surrounding workers.



Unrivaled Economic Value

Efficient maintenance with the best cost-effectiveness

Innovative energy consumption and equipment operation rate reflecting driver's need are enhanced with higher system reliability and convenient, economical follow-up management.



Replacement of battery from the side

A deep drop type battery can be easily and quickly removed and installed (through the side of the forklift) using the fork of a 3.5 ton (or less) forklift or 1.5ton hand pallet truck with a dedicated pallet without the need for expensive equipment like a crane.



Convenient battery charging

Batteries may be charged by connecting a charger connector to a charging port without the separation of battery cables connected to the frame. In addition, the proximity sensor of the exclusive port limits the operation of the equipment during the connection of charger cables.



Hydraulic motor room cooling system

For the efficient cooling of the Hydraulic motor room, the outdoor air inlet (fan) and indoor air outlet (fan) in the room are separately arranged using the left- and right-side covers.



Warning for Safety and Major Function Parts Reliability

Issues related to safety and major function parts reliability such as low brake oil level, battery discharge, and high temperature in controller and motor will trigger the warning sound and lamp. Programming and adjustment can be performed through Zapi Smart Console Programmer which is sold separately.

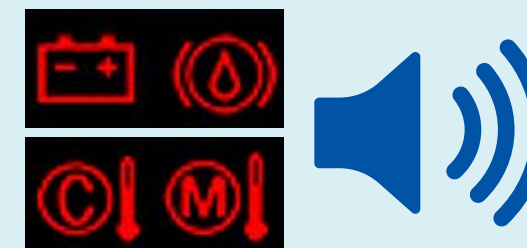

Waterproof and dustproof key switches

The lifespan and durability of the contact point were made to last long for the purpose of increasing the reliability of the electric/electronic system and an ignition key switch with a cap is used. Made by Honeywell, this product prevents moisture and dust from getting into the key switch.



Sealed micro switches - MCV

Sealed micro switches are applied in the hydraulic control lever system, thus the reliability of the hydraulic control system is guaranteed against the possible inflow of outdoor dust and water.



Cost-effective Lithium-ion batteries (OPT)

Rapidly chargeable Lithium-ion batteries ensure sound performance of the equipment with vastly reduced charge times, allowing extended hours of continued operation on a single charge. Moreover, they last at least twice longer than lead/ sulfuric acid counterparts, and do not necessitate management of distilled water. Also, being cathode active materials, they use phosphoric acid-iron compounds, which brings down the cost and eliminates the risk of explosion, making them even safer and more cost effective.

Benefits of HYUNDAI Lithium-ion batteries



Long hours of continuous operation

- Continued operations possible throughout the day with only auxiliary charge during equipment stoppage and meal time
- No need for spare batteries and charging facilities



Safety

- Use of non-explosive phosphoric acid-iron compounds
- Enclosed battery case made of high-strength steel
- Prevention of overheating, excessive electricity discharge or recharging through Battery Manage System



Easy maintenance

- No need to replenish distilled water or electrolytes
- Battery life at least twice longer than that of lead / sulfuric acid batteries (over 2,500 cycles)
- No emission of harmful gases and no restriction on the charging location



Cost savings

- Charging efficiency higher than lead / sulfuric acid batteries (70% → 95%)
- More affordable than NCM Lithium-ion batteries (at ~2/3 of the price of NCM batteries)
- 10,000 operational hours guaranteed for 5 years



- Lithium-ion battery capacity :
- 25BE-X : 51.2V - 450Ah
- 30/35BE-X : 83.2V - 450Ah

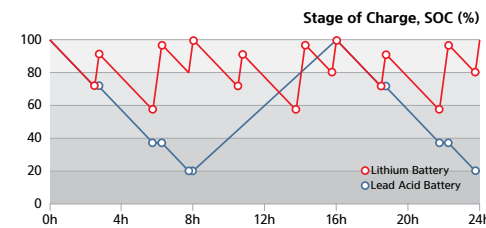

- Graph comparing the charge and discharge

Dimension

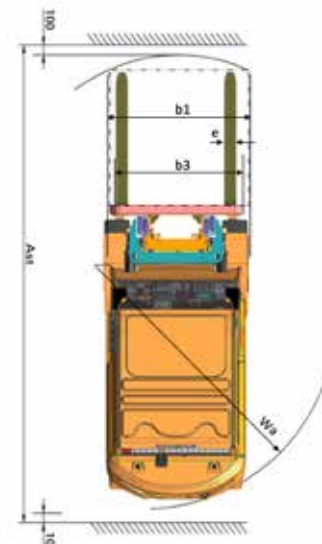
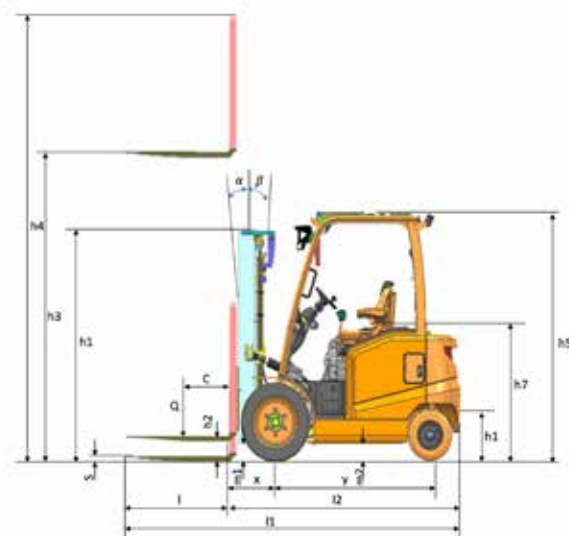

Specification

Identification				
	Manufacturer		Hyundai	
	Manufacturer's type designation		25BE-X	30BE-X
1.1	Drive		Electric-48V	Electric-80V
1.2	Type Of Operation		seated	seated
1.3	Load Capacity / Rated Load	kg	2,500	3,000
1.4	Load Center Distance	mm	500	500
1.5	Load Distance, Center Of Drive Axle To Fork	mm	473	473
1.6	Wheelbase	mm	1,490	1,680
Weights				
2.1	Service Weight	Kg	4,484	4,947
2.2	Axle Loading, Loaded Front/Rear	Kg	6,107/877	7,020/927
2.3	Axle Loading, Unloaded Front/Rear	kg	1,974/2,510	2,282/2,665
Wheels, Chassis				
3.1	Tires : Solid Rubber, Pneumatic, Non Marking		S, P	S, P
3.2	Tire Size, Front		28x9-15/-16	28x9-15/-16
3.3	Tire Size, Rear		18x7-8/-16	18x7-8/-16
3.5	Wheels, Number Front / Rear		2x/2	2x/2
3.6	Tread, Front	b10 (mm)	1,005	1,005
3.7	Tread, Rear	b11 (mm)	996	996
Basic Dimensions				
4.1	Tilt Of Mast Forward/Backward	Degrees	6/10	6/10
4.2	Height, Mast Lowered	H1 (mm)	2,040	2,040
4.3	Free Lift	H2 (mm)	150	150
4.4	Lift Height	H3 (mm)	3,005	3,005
4.5	Height, Mast Extended	H4 (mm)	4,185	4,185
4.7	Height Of Overhead Guard (Cabin)	H5 (mm)	2,175	2,175
4.8	Seat Height / Stand Height Rel. To Sip	H7 (mm)	1,200	1,200
4.12	Coupling Height	H10 (mm)	480	480
4.19	Overall Length	l1 (mm)	3,410	3,600
4.20	Length To Face Of Forks	L2 (mm)	2,360	2,502
4.21	Overall Width	b1 (mm)	1,215	1,215
4.22	Fork Dimensions	l x e x s (mm)	45x100x1050	45x125x1050
4.23	Fork Carriage Iso 2328, Class / Type A, B		II/A	III/A
4.24	Fork-Carriage Width	b3 (mm)	1,102	1,102
4.31	Ground Clearance, Below Mast, Loaded	m1 (mm)	142	142
4.32	Ground Clearance, Center Of Wheelbase	M2 (mm)	160	160
4.34.1	Aisle Width For Pallets 1000 X 1200 Crossways	Ast (mm)	3,858	4,060
4.34.2	Aisle Width For Pallets 800 X 1200 Lengthways	Ast (mm)	4,008	4,210
4.35	Turning Radius	Wa (mm)	2,135	2,337
Performance Data				
5.1	Travel Speed, Loaded / Unloaded	Km/h	14/15	14/15
5.2	Lift Speed, Loaded / Unloaded	Mm/s	300/450	300/450
5.3	Lowering Speed, Loaded / Unloaded	Mm/s	500/350	500/350
5.6	Max. Drawbar Pull, Loaded / Unloaded	N	13,328/-	14,210/-
5.8	Max. Gradeability, Loaded / Unloaded	%	15	15
5.10	Service Brake		Drum brake	Drum brake
Motor / Battery				
6.1	Drive Motor Rating S2 60 Min	kW	10	14
6.2	Lift Motor Rating At S3 15%	kW	14	16.5
6.4	Battery Voltage, Nominal Capacity (Opt)	V/Ah	48/600(660)	80/500(550)
6.5	Battery Weight	kg	950	1,295
6.7	Battery Compartment Dimensions L/W/H	mm	984x466x744	984x660x744
Other Details				
8.1	Type Of Drive Control		AC	AC
8.2	Operating Pressure, System / Attachments	bar	190/130	190/130
8.3	Oil Volume For Attachments	LPM	40	40

25BE-X											
Mast Type	Maximum Fork Height	Overall Height (Lowered)	Free Lift Height			Mast Tilt		Load capacity without Sideshift	Load capacity with Sideshift	Truck Weight (Unloaded)	
			With Load Backrest	Without Load Backrest	Without Load Backrest (3/4-SPOOL)	Fwd	Bwd	500mm LC	500mm LC		
			mm	mm	mm	deg	deg	kg	kg		
2 Stage Limited Free Lift	*V300	3,005	2,040	155	155	155	6	10	2,500	2,500	4,484
	V330	3,305	2,190	155	155	155	6	10	2,500	2,460	4,508
	V400	4,005	2,590	155	155	155	6	10	2,460	2,320	4,580
	V450	4,505	2,890	155	155	155	6	6	2,350	2,230	4,651
	V500	5,005	3,140	155	155	155	6	6	2,260	2,140	4,693
2 Stage Full Free Lift	VF295	2,955	2,040	860	1,314	1,314	6	6	2,500	2,500	4,526
	VF325	3,255	2,190	1,010	1,464	1,464	6	6	2,500	2,450	4,560
	VF345	3,455	2,290	1,110	1,564	1,564	6	6	2,500	2,410	4,583
3 Stage Full Free Lift	TF430	4,305	2,040	860	1,314	1,175	6	6	2,370	2,240	4,671
	TF450	4,505	2,140	960	1,414	1,325	6	6	2,330	2,200	4,692
	TF470	4,705	2,190	1,010	1,464	1,325	6	6	2,290	2,170	4,705
	TF500	5,005	2,290	1,110	1,564	1,425	6	6	2,240	2,120	4,727
	TF550	5,505	2,490	1,310	1,764	1,780	6	6	2,150	2,030	4,773
	TF600	6,005	2,690	1,510	1,964	1,875	6	6	2,050	1,940	4,865

* V : 2 Stage wide visibility lift mast / VF : 2 Stage wide visibility full free lift mast / TF : Triplex full free lift mast * : Standard

35BE-X											
Mast Type	Maximum Fork Height	Overall Height (Lowered)	Free Lift Height			Mast Tilt		Load capacity without Sideshift	Load capacity with Sideshift	Truck Weight (Unloaded)	
			With Load Backrest	Without Load Backrest	Without Load Backrest (3/4-SPOOL)	Fwd	Bwd	500mm LC	500mm LC		
			mm	mm	mm	deg	deg	kg	kg		
2 Stage Limited Free Lift	*V300	3,005	2,040	155	155	155	6	10	3,500	3,500	5,272
	V330	3,305	2,190	155	155	155	6	10	3,500	3,440	5,298
	V400	4,005	2,590	155	155	155	6	10	3,460	3,250	5,374
	V450	4,505	2,890	155	155	155	6	6	3,320	3,120	5,447
	V500	5,005	3,140	155	155	155	6	6	3,200	3,010	5,492
2 Stage Full Free Lift	VF295	2,955	2,040	860	1,314	1,314	6	6	3,500	3,480	5,373
	VF325	3,255	2,190	1,010	1,464	1,464	6	6	3,500	3,390	5,408
	VF345	3,455	2,290	1,110	1,564	1,564	6	6	3,500	3,340	5,444
3 Stage Full Free Lift	TF430	4,305	2,040	860	1,314	1,175	6	6	3,350	3,140	5,471
	TF450	4,505	2,140	960	1,414	1,325	6	6	3,300	3,090	5,494
	TF470	4,705	2,190	1,010	1,464	1,325	6	6	3,250	3,050	5,507
	TF500	5,005	2,290	1,110	1,564	1,425	6	6	3,180	2,980	5,529
	TF550	5,505	2,490	1,310	1,764	1,780	6	6	3,060	2,870	5,580
	TF600	6,005	2,690	1,510	1,964	1,875	6	6	2,810	2,690	5,674

* V : 2 Stage wide visibility lift mast / VF : 2 Stage wide visibility full free lift mast / TF : Triplex full free lift mast * : Standard

30BE-X											
Mast Type	Maximum Fork Height	Overall Height (Lowered)	Free Lift Height			Mast Tilt		Load capacity without Sideshift	Load capacity with Sideshift	Truck Weight (Unloaded)	
			With Load Backrest	Without Load Backrest	Without Load Backrest (3/4-SPOOL)	Fwd	Bwd	500mm LC	500mm LC		
			mm	mm	mm	deg	deg	kg	kg		
2 Stage Limited Free Lift	*V300	3,005	2,040	155	155	155	6	10	3,000	3,000	4,947
	V330	3,305	2,190	155	155	155	6	10	3,000	2,970	4,973
	V400	4,005	2,590	155	155	155	6	10	2,980	2,810	5,049
	V450	4,505	2,890	155	155	155	6	6	2,860	2,700	5,122
	V500	5,005	3,140	155	155	155	6	6	2,750	2,590	5,167
2 Stage Full Free Lift	VF295	2,955	2,040	860	1,314	1,314	6	6	3,000	3,000	5,048
	VF325	3,255	2,190	1,010	1,464	1,464	6	6	3,000	2,990	5,083
	VF345	3,455	2,290	1,110	1,564	1,564	6	6	3,000	2,900	5,119
3 Stage Full Free Lift	TF430	4,305	2,040	860	1,314	1,175	6	6	2,890	2,710	5,146
	TF450	4,505	2,140	960	1,414	1,325	6	6	2,840	2,670	5,169
	TF470	4,705	2,190	1,010	1,464	1,325	6	6	2,800	2,630	5,182
	TF500	5,005	2,290	1,110	1,564	1,425	6	6	2,740	2,570	5,204
	TF550	5,505	2,490	1,310	1,764	1,780	6	6	2,630	2,470	5,255
	TF600	6,005	2,690	1,510	1,964	1,875	6	6	2,520	2,370	5,349

* V : 2 Stage wide visibility lift mast / VF : 2 Stage wide visibility full free lift mast / TF : Triplex full free lift mast * : Standard

Load Capacity

